

Габаритные и установочные размеры

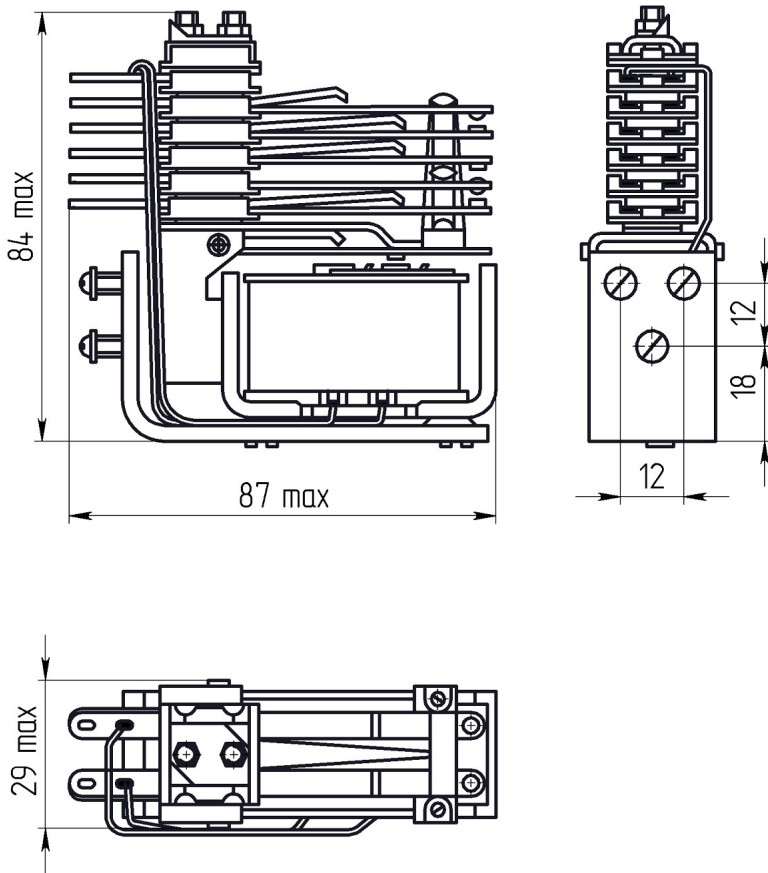

Внешний вид

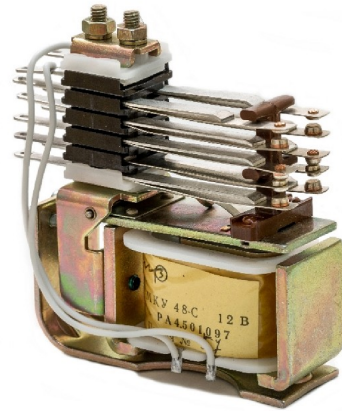

Электрическая принципиальная схема

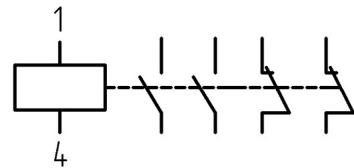

48- -

50

48-

(- ; - ; 2 2) /

-99

360



"

"

48- 4.500.261 0.450.002

48

1900 ±285

60

60

40

9

200

0,1

1500

220

5

380

5

250000

-50 +50

85000 106600

4 g 5 80

150 g 9

15 g 5000

15

, °C



48- 4.500.261 0.450.002

()

